

### Product Image

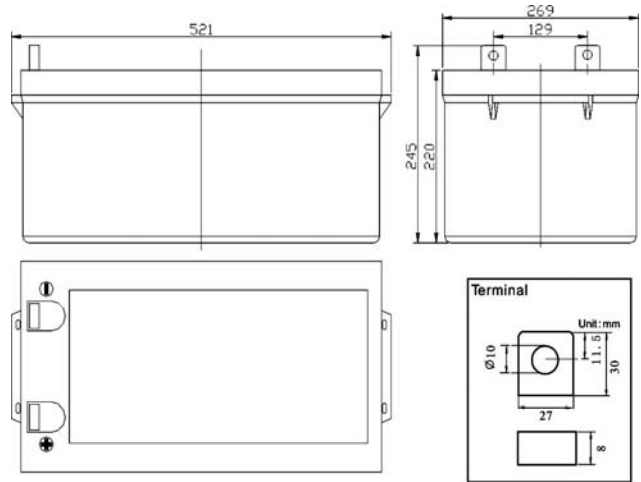

### Product Dimensions



### Characteristics

Nominal Voltage		12V
Nominal Capacity (10 hour rate)		250Ah
Capacity 25°C (77°F)	20 hour rate (13.9A)	278Ah
	5 hour rate (45.7A)	228Ah
	1 hour rate (184.8A)	184.8Ah
Internal Resistance	Full Charged Battery 25°C	≤2.0m Ω
Capacity affected by Temperature (10 hour )	40°C (104°F)	102%
	25°C (77°F)	100%
	0°C (32°F)	85%
	-15°C (5°F)	65%
Self-Discharge 25°C (77°F) Capacity	after 3 month storage	90%
	after 6 month storage	80%
	after 12 month storage	62%
Charge (Constant Voltage) 25°C (77°F)	Float	Initial Charging Current Less than 50A Voltage 13.6-13.8V
	Cycle	Initial Charging Current Less than 50A Voltage 14.4-14.9V

### Packaging

Battery Dimensions	Length	521mm
	Width	269mm
	Height	220mm
	Total Height	245mm
Box Dimensions	Length	537mm
	Width	284mm
	Height	299mm
Quantity Per Box		1 PC per box
Net weight Per Cell		70.0 kg±500g
Net weight Per Box		70.0kg
Gross Weight		70.8kg

#### Discharge Constant Current per Cell (Amperes at 77°F25°C)

F.V/Time	5min	10min	15min	30min	45min	1h	2h	3h	5h	8h	10h	20h
1.60V	840.6	560.0	422.1	262.6	188.4	184.8	101.4	74.1	47.7	29.1	26.0	14.4
1.65V	775.0	516.3	404.5	255.6	183.4	179.9	99.5	72.8	47.0	28.8	25.8	14.3
1.70V	788.1	525.0	386.9	248.6	178.3	174.9	97.7	71.4	46.4	28.6	25.5	14.2
1.75V	696.2	463.8	369.3	241.5	173.3	170.0	95.3	69.7	45.7	28.3	25.3	14.0
1.80V	656.8	437.5	351.8	234.5	168.3	165.0	93.0	68.0	45.0	28.0	25.0	13.9

#### Discharge Constant Power per Cell (Watts at 77°F 25°C)

F.V/Time	5min	10min	15min	30min	45min	1h	2h	3h	5h	8h	10h	20h
1.60V	1567.8	1044.4	787.2	489.8	351.4	344.7	189.1	138.2	89.0	54.3	48.5	26.9
1.65V	1445.3	962.8	754.4	476.7	342.0	335.4	185.6	135.7	87.7	53.8	48.0	26.7
1.70V	1469.8	979.1	721.6	463.6	332.6	326.2	182.1	133.2	86.4	53.3	47.6	26.4
1.75V	1298.3	864.9	688.8	450.5	323.2	317.0	177.8	130.0	85.2	52.7	47.1	26.1
1.80V	1224.8	815.9	656.0	437.3	313.8	307.7	173.4	126.8	83.9	52.2	46.6	25.9

**Note** The above data are average values, and can be obtained within 3 charge/discharge cycles. These are not minimum values. Cell and battery designs/specifications are subject to modification without notice. Contact **MCA** for the latest information.

### Performance Characteristics

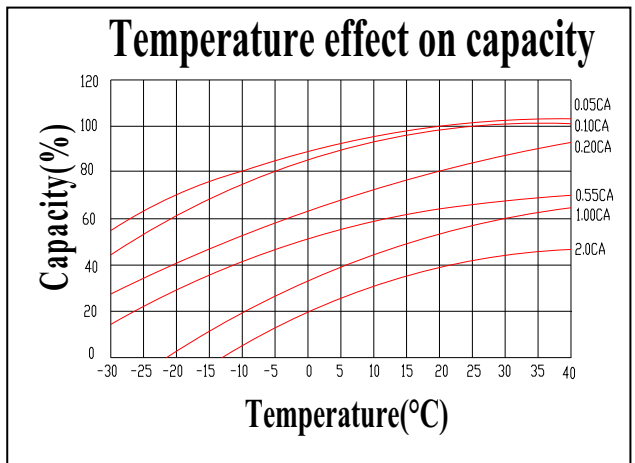
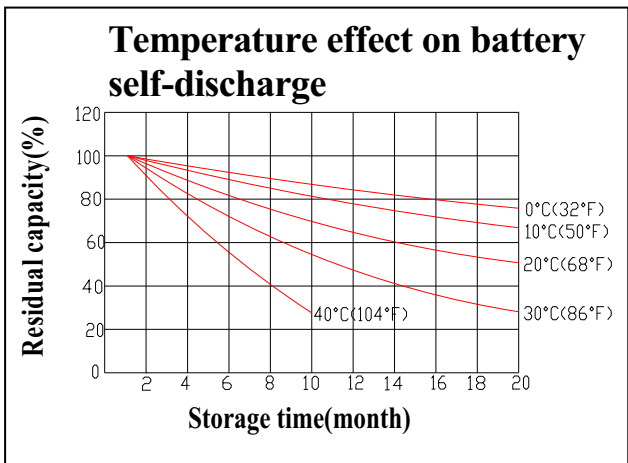
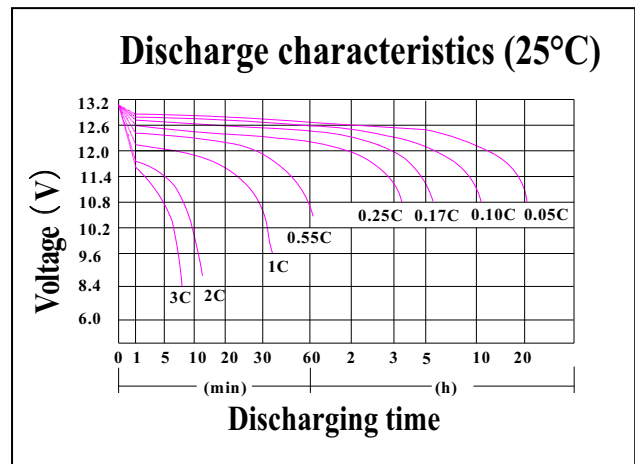
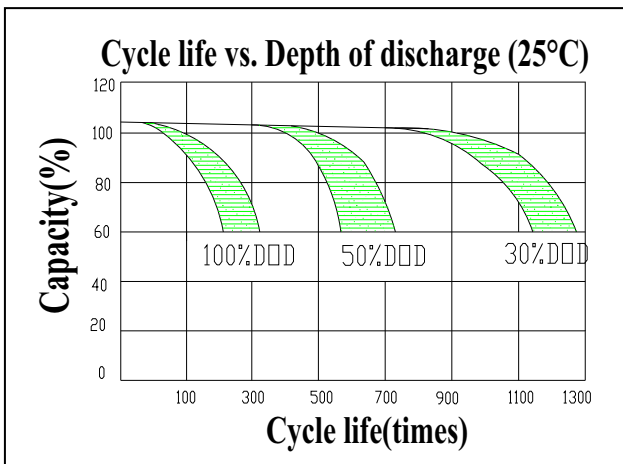
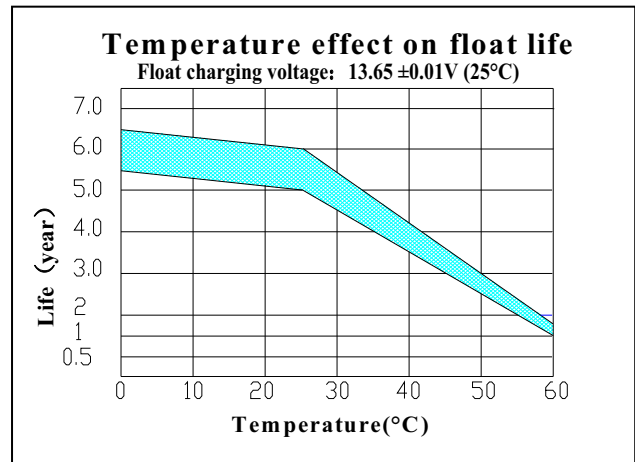
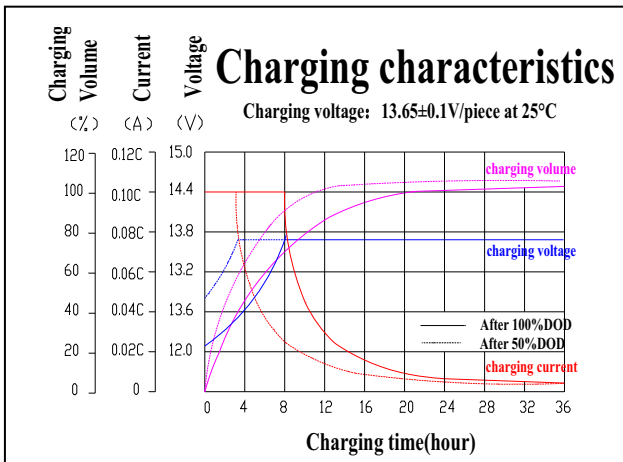

### Battery Construction

Component	Positive plate	Negative plate	Container	Cover	Safety valve	Terminal	Separator	Electrolyte
Raw material	Lead dioxide	Lead	ABS	ABS	Si-Rubber	Lead	Fiberglass	Sulfuric acid