

Product Image

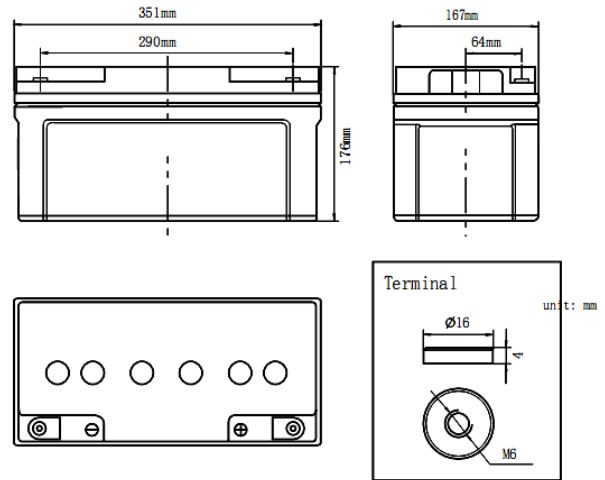

Product Dimensions



Characteristics

Nominal Voltage		12V
Nominal Capacity (10 hour rate)		70Ah
Capacity 25°C (77°F)	20 hour rate (3.89A)	77.8Ah
	5 hour rate (12.8A)	64.0Ah
	1 hour rate (46.6A)	46.6Ah
Internal Resistance	Full Charged Battery 25°C	$\leq 6.5m\Omega$
Capacity affected by Temperature (10 hour)	40°C (104°F)	102%
	25°C (77°F)	100%
	0°C (32°F)	85%
	-15°C (5°F)	65%
Self-Discharge 25°C (77°F) Capacity	after 3 month storage	90%
	after 6 month storage	80%
	after 12 month storage	62%
Charge (Constant Voltage) 25°C (77°F)	Float	Initial Charging Current Less than 17.5A Voltage 13.6-13.8V
	Cycle	Initial Charging Current Less than 17.5A Voltage 14.4-14.9V

Packaging

Battery Dimensions	Length	351mm
	Width	167mm
	Height	176mm
	Total Height	176mm
Box Dimensions	Length	365mm
	Width	181mm
	Height	224mm
Quantity Per Box		1 PC per box
Net weight Per Cell		22.5 kg±200g
Net weight Per Box		22.5kg
Gross Weight		23.0kg

Discharge Constant Current per Cell (Amperes at 77°F 25°C)

F.V/Time	5min	10min	15min	30min	45min	1h	2h	3h	5h	8h	10h	20h
1.60V	235.4	156.8	118.2	73.5	52.8	46.6	28.4	20.8	13.4	8.2	7.28	4.04
1.65V	217.0	144.6	113.3	71.6	51.3	45.3	27.9	20.4	13.2	8.1	7.21	4.00
1.70V	220.7	147.0	108.3	69.6	49.9	44.1	27.3	20.0	13.0	8.0	7.14	3.96
1.75V	194.9	129.9	103.4	67.6	48.5	42.8	26.7	19.5	12.8	7.9	7.07	3.92
1.80V	183.9	122.5	98.5	65.7	47.1	41.6	26.0	19.0	12.6	7.8	7.00	3.89

Discharge Constant Power per Cell (Watts at 77°F 25°C)

F.V/Time	5min	10min	15min	30min	45min	1h	2h	3h	5h	8h	10h	20h
1.60V	439.0	292.4	220.4	137.2	98.4	86.9	52.9	38.7	24.9	15.2	13.6	7.5
1.65V	404.7	269.6	211.2	133.5	95.8	84.5	52.0	38.0	24.6	15.1	13.4	7.5
1.70V	411.5	274.2	202.1	129.8	93.1	82.2	51.0	37.3	24.2	14.9	13.3	7.4
1.75V	363.5	242.2	192.9	126.1	90.5	79.9	49.8	36.4	23.9	14.8	13.2	7.3
1.80V	343.0	228.5	183.7	122.5	87.9	77.5	48.6	35.5	23.5	14.6	13.1	7.2

Note The above data are average values, and can be obtained within 3 charge/discharge cycles. These are not minimum values. Cell and battery designs/specifications are subject to modification without notice. Contact **MCA** for the latest information.

Performance Characteristics

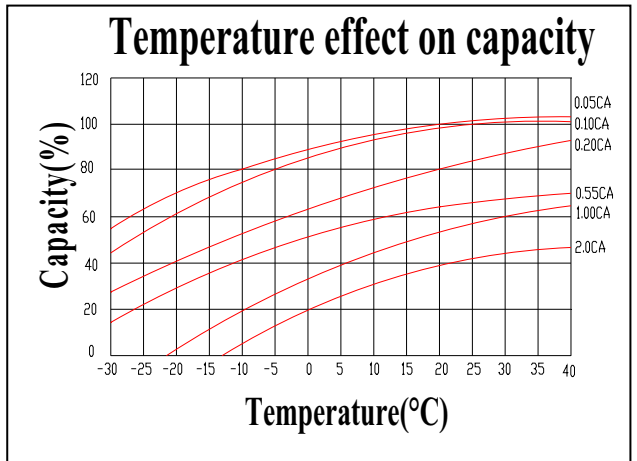
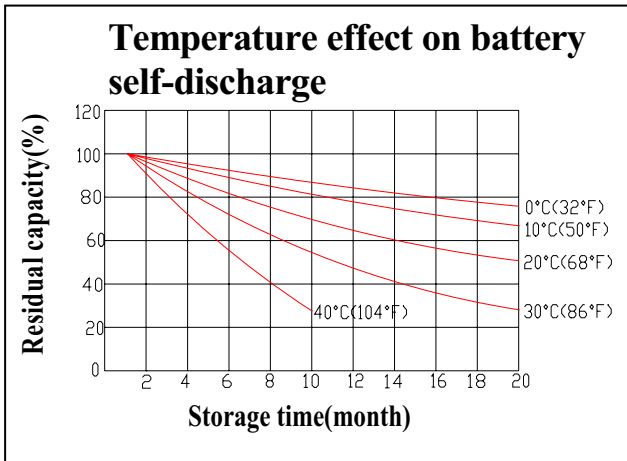
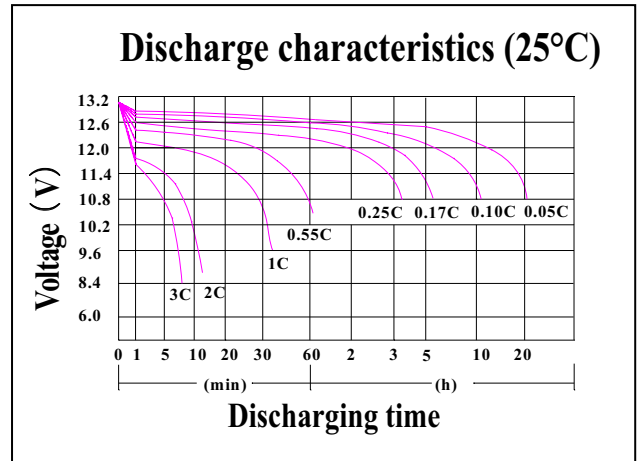
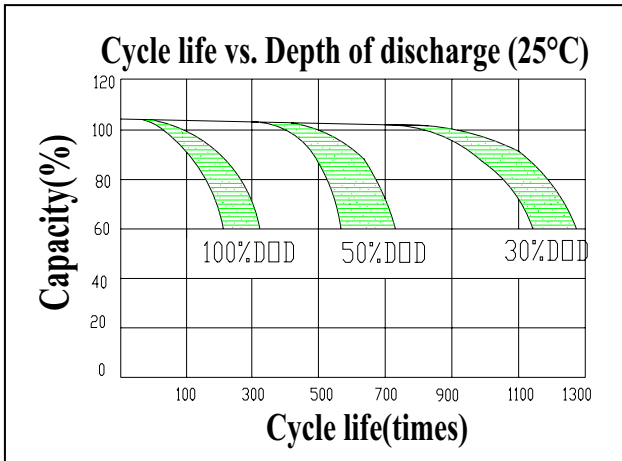
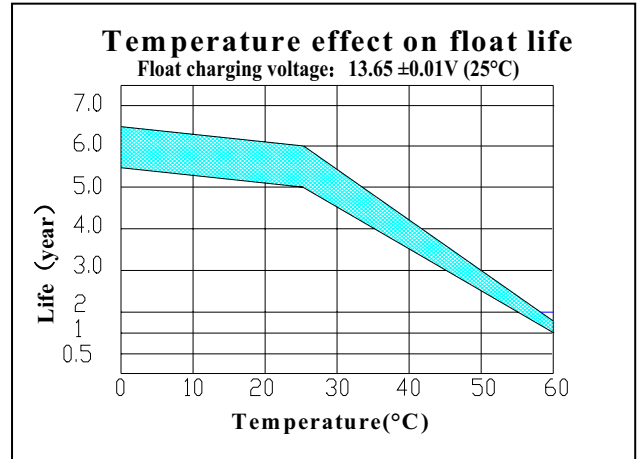
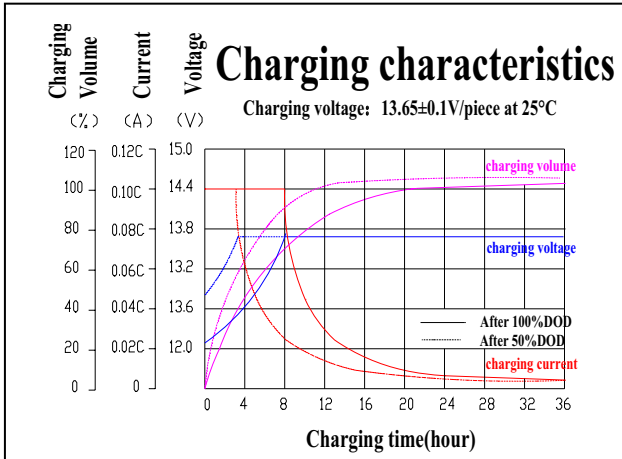

Battery Construction

Component	Positive plate	Negative plate	Container	Cover	Safety valve	Terminal	Separator	Electrolyte
Raw material	Lead dioxide	Lead	ABS	ABS	Si-Rubber	Copper	Fiberglass	Sulfuric acid