

### Product Image

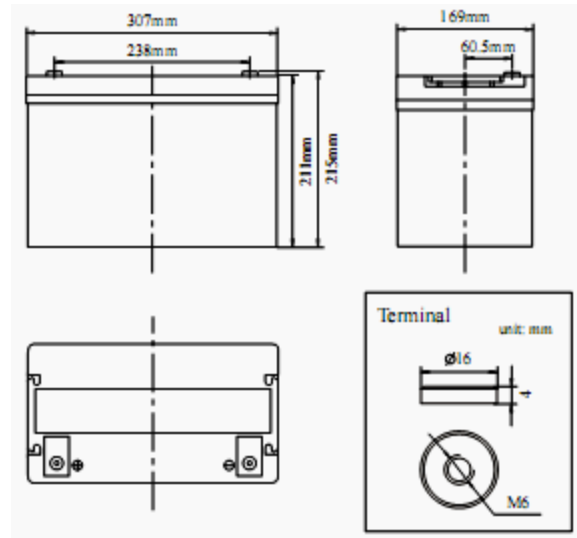

### Product Dimensions



### Characteristics

Nominal Voltage		12V
Nominal Capacity (10 hour rate)		90Ah
Capacity 25°C (77°F)	20 hour rate (5.0A)	100Ah
	5 hour rate (16.4A)	82Ah
	1 hour rate (59.9A)	59.9Ah
Internal Resistance	Full Charged Battery 25°C	≤5.5mΩ
Capacity affected by Temperature (10 hour)	40°C (104°F)	102%
	25°C (77°F)	100%
	0°C (32°F)	85%
	-15°C (5°F)	65%
Self-Discharge 25°C (77°F) Capacity	after 3 month storage	90%
	after 6 month storage	80%
	after 12 month storage	62%
Charge (Constant Voltage) 25°C (77°F)	Float	Initial Charging Current Less than 22.5A Voltage 13.6-13.8V
	Cycle	Initial Charging Current Less than 22.5A Voltage 14.4-14.9V

### Packaging

Battery Dimensions	Length	307mm
	Width	169mm
	Height	211mm
	Total Height	215mm
Box Dimensions	Length	323mm
	Width	183mm
	Height	257mm
Quantity Per Box		1 PC per box
Net weight Per Cell		27.3kg±300g
Net weight Per Box		27.3kg
Gross Weight		27.8kg

#### Discharge Constant Current per Cell (Amperes at 77°F 25°C)

F.V/Time	5min	10min	15min	30min	45min	1h	2h	3h	5h	8h	10h	20h
1.60V	302.6	201.6	152.0	94.6	67.8	59.9	36.5	26.7	17.2	10.5	9.36	5.19
1.65V	279.0	185.9	145.6	92.0	66.0	58.3	35.8	26.2	16.9	10.4	9.27	5.14
1.70V	283.7	189.0	139.3	89.5	64.2	56.7	35.2	25.7	16.7	10.3	9.18	5.09
1.75V	250.6	167.0	133.0	87.0	62.4	55.1	34.3	25.1	16.4	10.2	9.09	5.04
1.80V	236.4	157.5	126.6	84.4	60.6	53.5	33.5	24.5	16.2	10.1	9.00	5.00

#### Discharge Constant Power per Cell (Watts at 77°F 25°C)

F.V/Time	5min	10min	15min	30min	45min	1h	2h	3h	5h	8h	10h	20h
1.60V	564.4	376.0	283.4	176.3	126.5	111.7	68.1	49.8	32.0	19.6	17.5	9.7
1.65V	520.3	346.6	271.6	171.6	123.1	108.7	66.8	48.9	31.6	19.4	17.3	9.6
1.70V	529.1	352.5	259.8	166.9	119.7	105.7	65.6	47.9	31.1	19.2	17.1	9.5
1.75V	467.4	311.4	248.0	162.2	116.4	102.7	64.0	46.8	30.7	19.0	17.0	9.4
1.80V	440.9	293.7	236.2	157.4	113.0	99.7	62.4	45.7	30.2	18.8	16.8	9.3

**Note** The above data are average values, and can be obtained within 3 charge/discharge cycles. These are not minimum values. Cell and battery designs/specifications are subject to modification without notice. Contact **MCA** for the latest information.

### Performance Characteristics

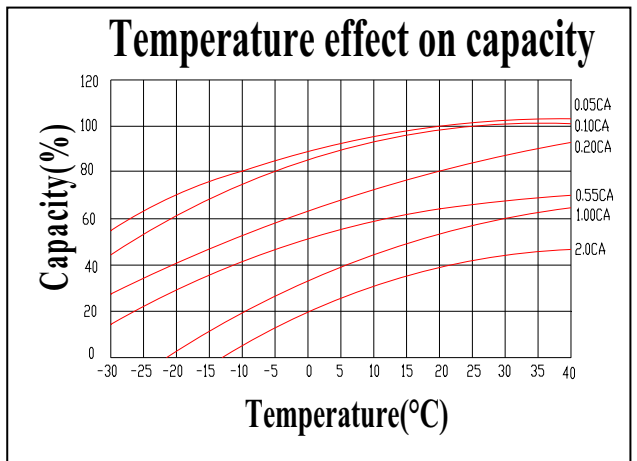
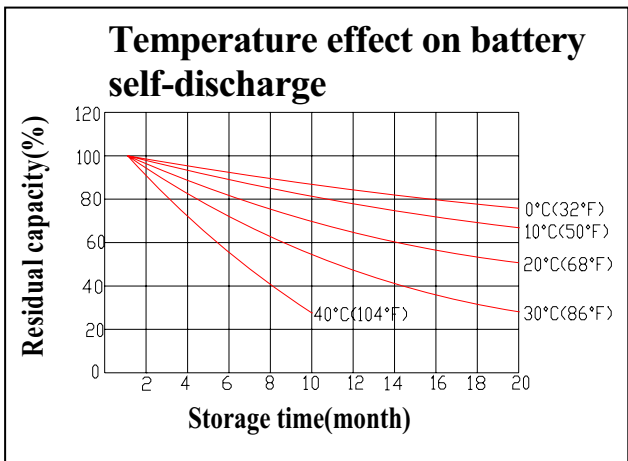
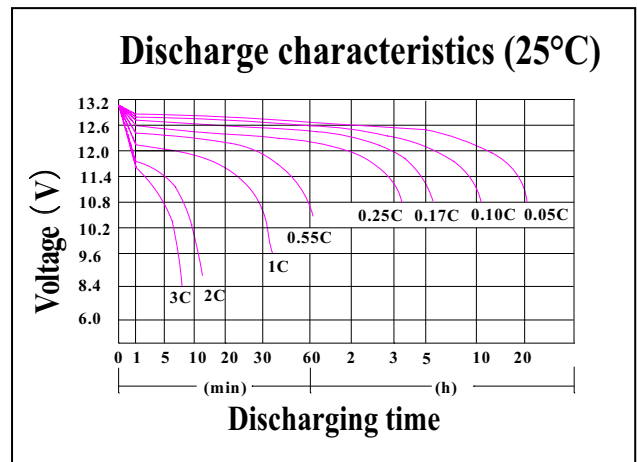
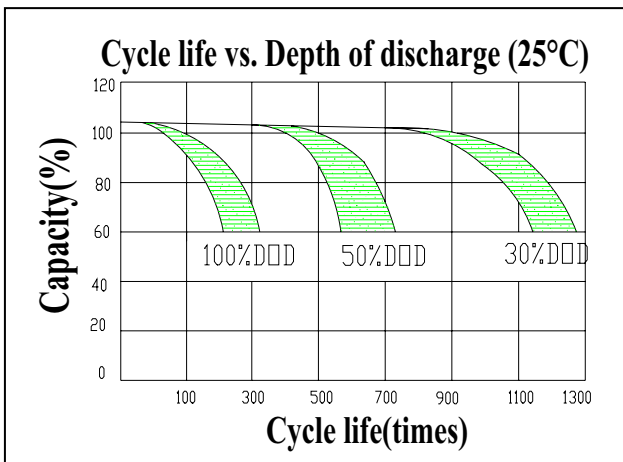
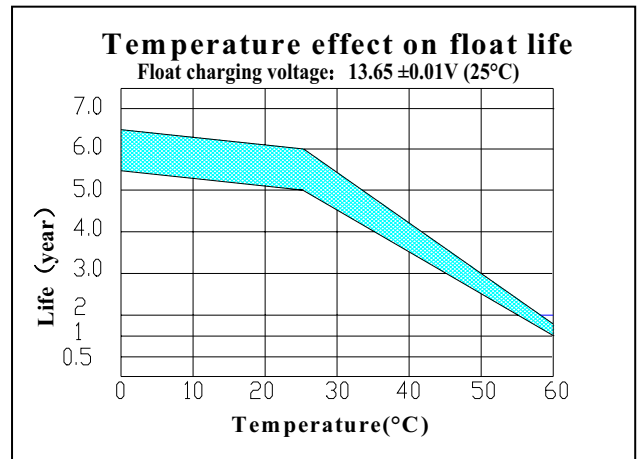
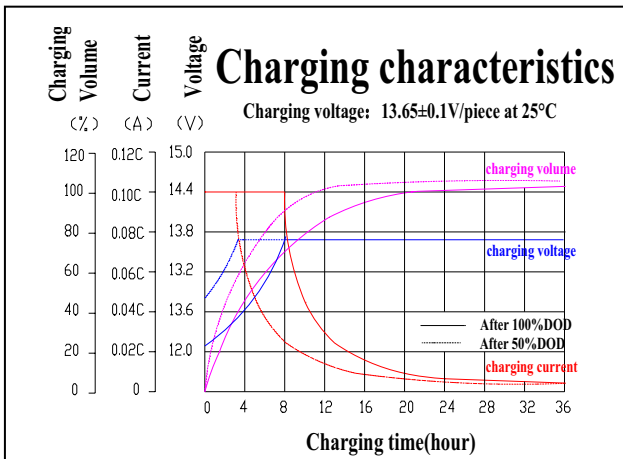

### Battery Construction

Component	Positive plate	Negative plate	Container	Cover	Safety valve	Terminal	Separator	Electrolyte
Raw material	Lead dioxide	Lead	ABS	ABS	Si-Rubber	Copper	Fiberglass	Sulfuric acid