

Product Image

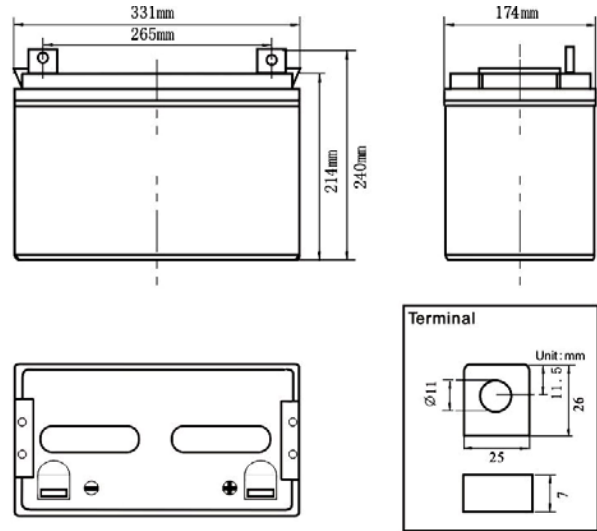

Product Dimensions



Characteristics

Nominal Voltage		12V
Nominal Capacity (20 hour rate)		120Ah
Capacity 25°C (77°F)	10 hour rate (10.9A)	109Ah
	5 hour rate (19.3A)	96.5Ah
	1 hour rate (70.7A)	70.7Ah
Internal Resistance	Full Charged Battery 25°C	≤4mΩ
Capacity affected by Temperature (10 hour)	40°C (104°F)	102%
	25°C (77°F)	100%
	0°C (32°F)	85%
	-15°C (5°F)	65%
Self-Discharge 25°C (77°F) Capacity	after 3 month storage	90%
	after 6 month storage	80%
	after 12 month storage	62%
Charge (Constant Voltage) 25°C (77°F)	Float	Initial Charging Current Less than 24.0A Voltage 13.6-13.8V
	Cycle	Initial Charging Current Less than 24.0A Voltage 14.4-14.9V

Packaging

Battery Dimensions	Length	331mm
	Width	174mm
	Height	214mm
	Total Height	240mm
Box Dimensions	Length	346mm
	Width	188mm
	Height	289mm
Quantity Per Box		1 PC per box
Net weight Per Cell		32.0kg±400g
Net weight Per Box		32.0kg
Gross Weight		32.5kg

Discharge Constant Current per Cell (Amperes at 77°F 25°C)

F.V/Time	5min	10min	15min	30min	45min	1h	2h	3h	5h	8h	10h	20h
1.60V	304.5	189.4	157.1	110.9	79.6	70.7	43.8	30.0	20.4	13.4	12.0	6.6
1.65V	299.0	186.0	154.2	108.9	78.2	69.5	43.0	29.4	20.0	13.2	11.8	6.5
1.70V	293.5	182.6	151.4	106.9	76.7	68.2	42.2	28.9	19.6	12.9	11.6	6.4
1.75V	287.9	179.1	148.5	104.9	75.3	66.9	41.4	28.3	19.3	12.7	11.3	6.2
1.80V	276.9	172.2	142.8	100.8	72.4	64.3	39.8	27.3	18.5	12.2	10.9	6.0

Discharge Constant Power per Cell (Watts at 77°F 25°C)

F.V/Time	5min	10min	15min	30min	45min	1h	2h	3h	5h	8h	10h	20h
1.60V	586.3	364.7	302.4	213.5	153.3	136.2	84.2	57.7	39.2	25.9	23.1	12.7
1.65V	575.6	358.0	296.9	209.6	150.5	133.7	82.7	56.7	38.5	25.4	22.7	12.5
1.70V	564.9	351.4	291.4	205.7	147.7	131.2	81.2	55.6	37.8	24.9	22.2	12.2
1.75V	554.3	344.8	285.9	201.9	144.9	128.7	79.6	54.6	37.1	24.4	21.8	12.0
1.80V	533.0	331.5	274.9	194.1	139.3	123.8	76.6	52.5	35.7	23.5	21.0	11.5

Note The above data are average values, and can be obtained within 3 charge/discharge cycles. These are not minimum values. Cell and battery designs/specifications are subject to modification without notice. Contact **MCA** for the latest information.

Performance Characteristics

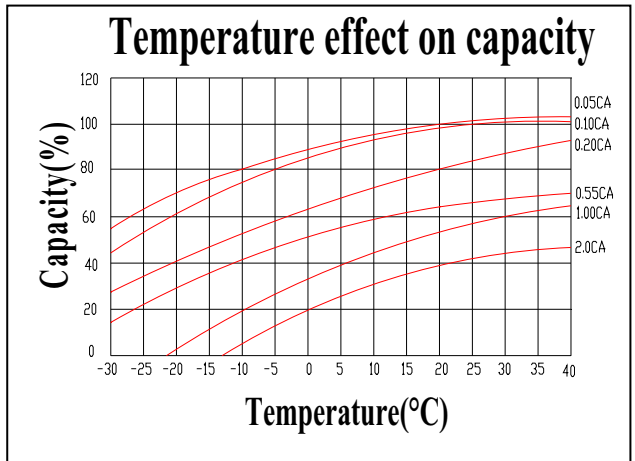
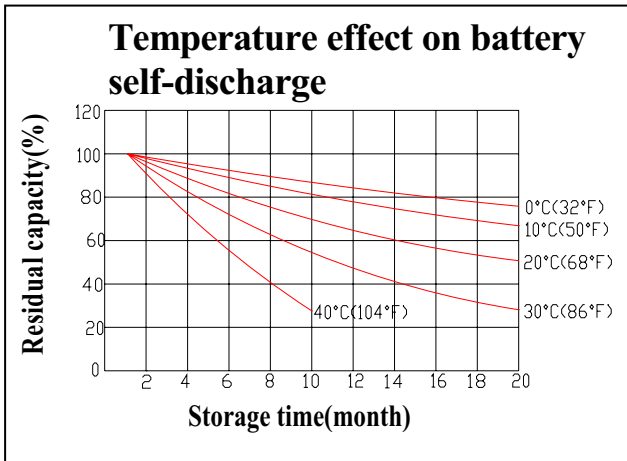
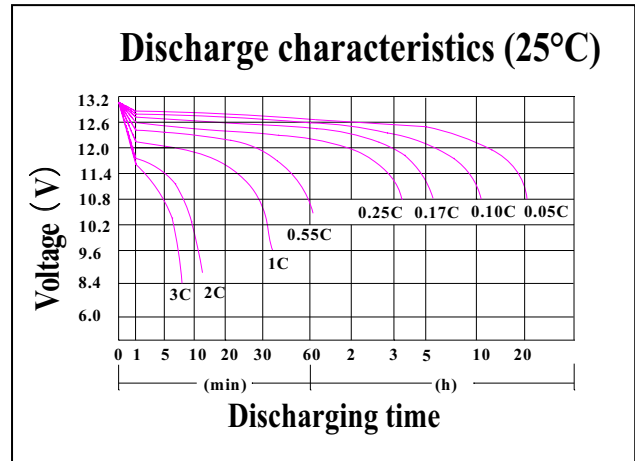
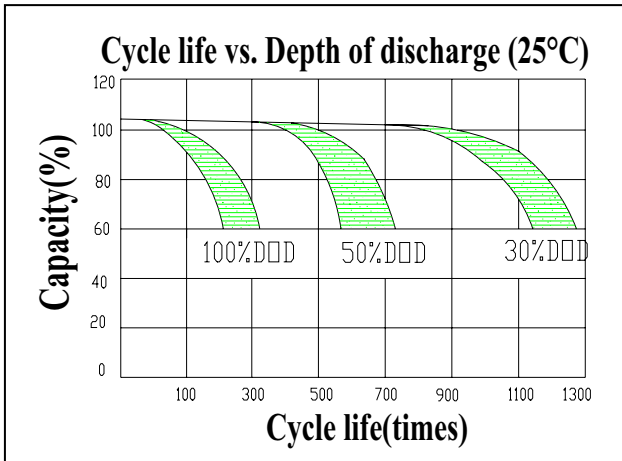
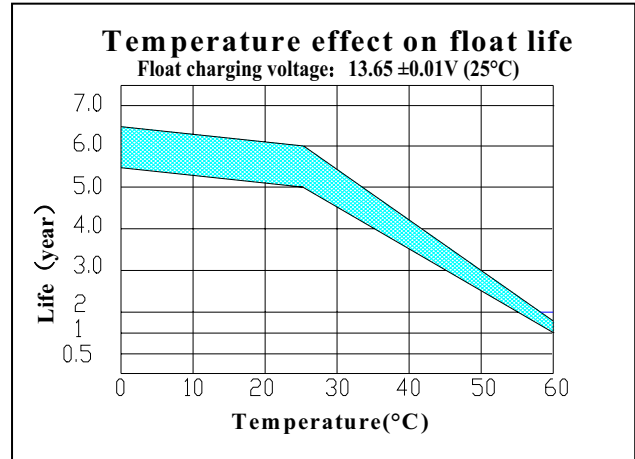
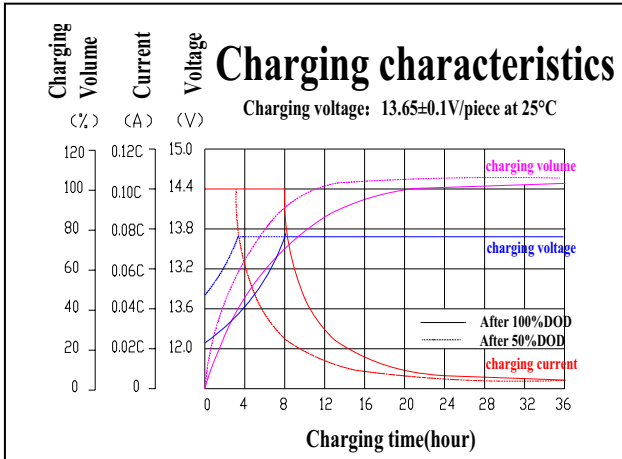

Battery Construction

Component	Positive plate	Negative plate	Container	Cover	Safety valve	Terminal	Separator	Electrolyte
Raw material	Lead dioxide	Lead	ABS	ABS	Si-Rubber	Lead	Fiberglass	Sulfuric acid