

Product Image

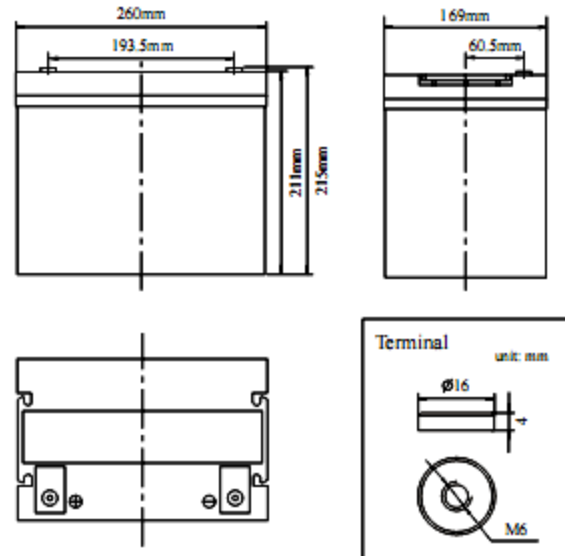

Product Dimensions



Characteristics

Nominal Voltage		12V
Nominal Capacity (20 hour rate)		80Ah
Capacity 25°C (77°F)	10 hour rate (7.2A)	72Ah
	5 hour rate (12.7A)	63.5Ah
	1 hour rate (46.7A)	46.7Ah
Internal Resistance	Full Charged Battery 25°C	≤6.0mΩ
Capacity affected by Temperature (10 hour)	40°C (104°F)	102%
	25°C (77°F)	100%
	0°C (32°F)	90%
	-15°C (5°F)	70%
Self-Discharge 25°C (77°F) Capacity	after 3 month storage	92%
	after 6 month storage	84%
	after 12 month storage	65%
Charge (Constant Voltage) 25°C (77°F)	Float	Initial Charging Current Less than 20.0A Voltage 13.6-13.8V
	Cycle	Initial Charging Current Less than 20.0A Voltage 14.4-14.9V

Packaging

Battery Dimensions	Length	260mm
	Width	169mm
	Height	211mm
	Total Height	215mm
Box Dimensions	Length	275mm
	Width	183mm
	Height	272mm
Quantity Per Box		1 PC per box
Net weight Per Cell		24.5 kg±200g
Net weight Per Box		24.5kg
Gross Weight		25.0kg

Discharge Constant Current per cell (Amperes at 77°F 25°C)

F.V/Time	5min	10min	15min	30min	45min	1h	2h	3h	5h	8h	10h	20h
1.60V	201.2	125.1	103.8	73.3	52.6	46.7	28.9	19.8	13.5	8.9	7.9	4.4
1.65V	197.5	122.9	101.9	71.9	51.6	45.9	28.4	19.4	13.2	8.7	7.8	4.3
1.70V	193.9	120.6	100.0	70.6	50.7	45.0	27.9	19.1	13.0	8.5	7.6	4.2
1.75V	190.2	118.3	98.1	69.3	49.7	44.2	27.3	18.7	12.7	8.4	7.5	4.1
1.80V	182.9	113.8	94.3	66.6	47.8	42.5	26.3	18.0	12.2	8.1	7.2	4.0

Discharge Constant Power per cell (Watts at 77°F 25°C)

F.V/Time	5min	10min	15min	30min	45min	1h	2h	3h	5h	8h	10h	20h
1.60V	387.2	240.9	199.7	141.0	101.2	90.0	55.6	38.1	25.9	17.1	15.2	8.4
1.65V	380.2	236.5	196.1	138.5	99.4	88.3	54.6	37.4	25.4	16.8	15.0	8.2
1.70V	373.2	232.1	192.5	135.9	97.6	86.7	53.6	36.7	25.0	16.5	14.7	8.1
1.75V	366.1	227.7	188.8	133.3	95.7	85.0	52.6	36.0	24.5	16.1	14.4	7.9
1.80V	352.0	219.0	181.6	128.2	92.0	81.8	50.6	34.7	23.6	15.5	13.9	7.6

Note The above data are average values, and can be obtained within 3 charge/discharge cycles. These are not minimum values. Cell and battery designs/specifications are subject to modification without notice. Contact **MCA** for the latest information.

Performance Characteristics

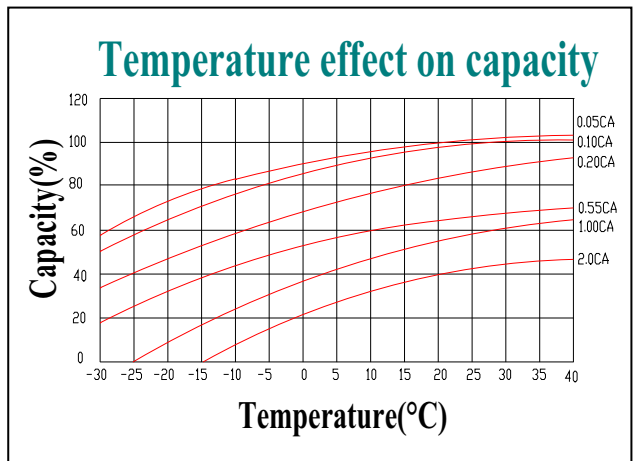
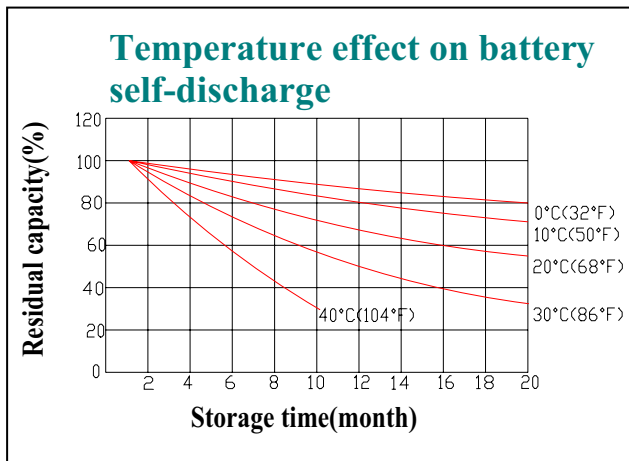
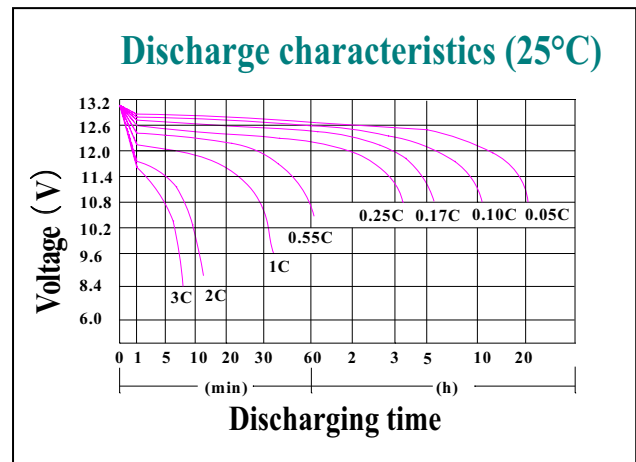
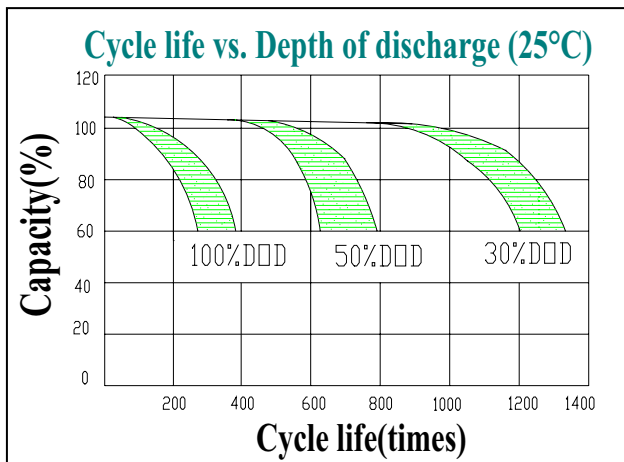
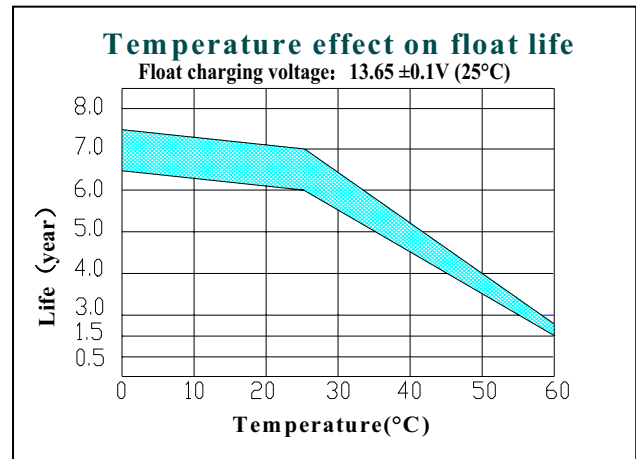
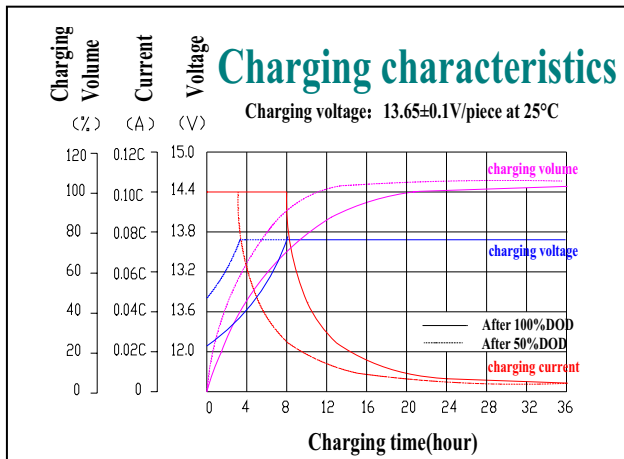

Battery Construction

Component	Positive plate	Negative plate	Container	Cover	Safety valve	Terminal	Separator	Electrolyte
Raw material	Lead dioxide	Lead	ABS	ABS	Si-Rubber	Copper	Fiberglass	GEL