

Product Image

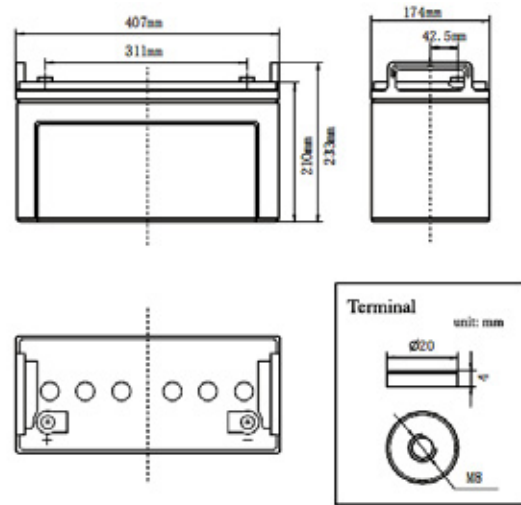

Product Dimensions



Characteristics

Nominal Voltage		12V
Nominal Capacity (20 hour rate)		120Ah
Capacity 25°C (77°F)	10 hour rate (10.8A)	108Ah
	5 hour rate (19.1A)	95.5Ah
	1 hour rate (66.5A)	66.5Ah
Internal Resistance	Full Charged Battery 25°C	≤4.8mΩ
Capacity affected by Temperature (10 hour)	40°C (104°F)	102%
	25°C (77°F)	100%
	0°C (32°F)	85%
	-15°C (5°F)	65%
Self-Discharge 25°C (77°F) Capacity	after 3 month storage	90%
	after 6 month storage	80%
	after 12 month storage	62%
Charge (Constant Voltage) 25°C (77°F)	Float	Initial Charging Current Less than 24A Voltage 13.6-13.8V
	Cycle	Initial Charging Current Less than 24A Voltage 14.4-14.9V

Packaging

Battery Dimensions	Length	407mm
	Width	174mm
	Height	210mm
	Total Height	233mm
Box Dimensions	Length	422mm
	Width	188mm
	Height	289mm
Quantity Per Box		1 PC per box
Net weight Per Cell		38.0 kg±200g
Net weight Per Box		38.0kg
Gross Weight		38.5kg

Discharge Constant Current per Cell (Amperes at 77°F/25°C)

F.V/Time	5min	10min	15min	30min	45min	1h	2h	3h	5h	8h	10h	20h
1.60V	285.1	181.8	154.4	98.6	72.5	66.5	42.3	29.7	20.2	13.3	11.9	6.6
1.65V	279.9	178.5	151.6	96.8	71.2	65.3	41.5	29.2	19.8	13.1	11.7	6.48
1.70V	274.8	175.2	148.8	95.0	69.8	64.1	40.8	28.6	19.5	12.8	11.4	6.36
1.75V	269.6	171.8	146.0	93.2	68.5	62.9	40.0	28.1	19.1	12.6	11.2	6.24
1.80V	259.2	165.2	140.4	89.6	65.9	60.5	38.4	27.0	18.4	12.1	10.8	6.00

Discharge Constant Power per Cell (Watts at 77°F 25°C)

F.V/Time	5min	10min	15min	30min	45min	1h	2h	3h	5h	8h	10h	20h
1.60V	548.9	349.9	297.3	189.8	139.5	128.1	81.4	57.2	38.9	25.6	22.9	12.7
1.65V	538.9	343.5	291.9	186.4	137.0	125.7	79.9	56.1	38.2	25.1	22.5	12.5
1.70V	528.9	337.2	286.5	182.9	134.4	123.4	78.5	55.1	37.5	24.7	22.0	12.2
1.75V	518.9	330.8	281.1	179.5	131.9	121.1	77.0	54.1	36.8	24.2	21.6	12.0
1.80V	499.0	318.1	270.3	172.6	126.8	116.4	74.0	52.0	35.3	23.3	20.8	11.5

Note The above data are average values, and can be obtained within 3 charge/discharge cycles. These are not minimum values. Cell and battery designs/specifications are subject to modification without notice. Contact **MCA** for the latest information.

Performance Characteristics

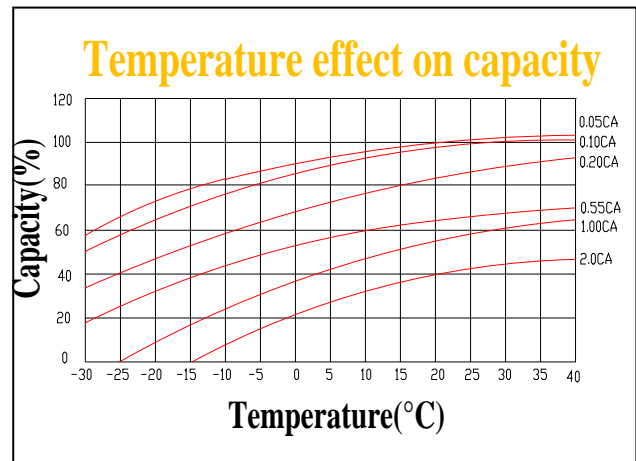
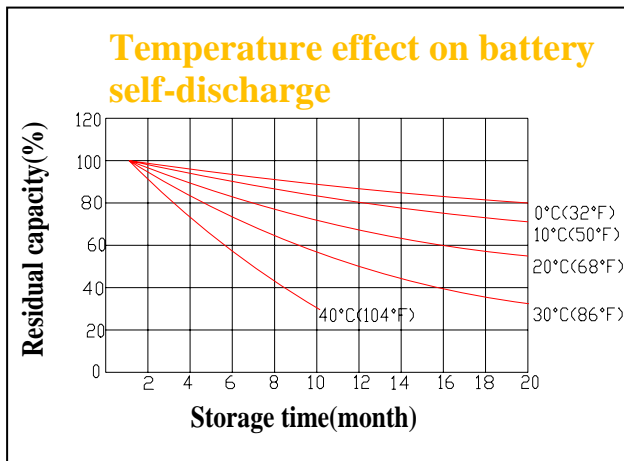
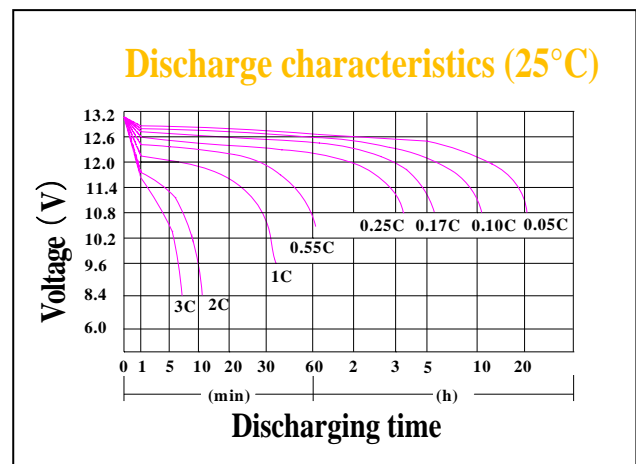
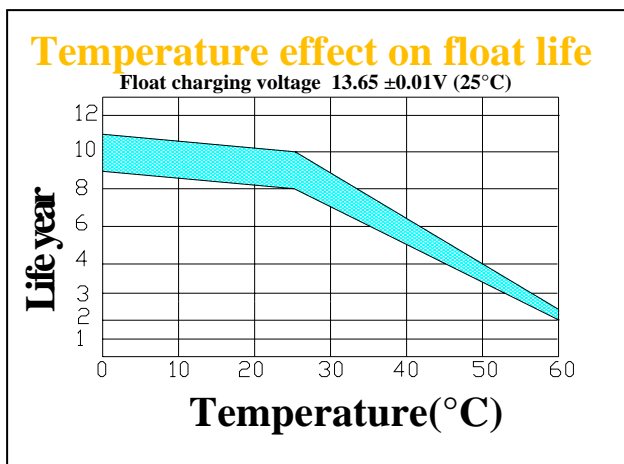
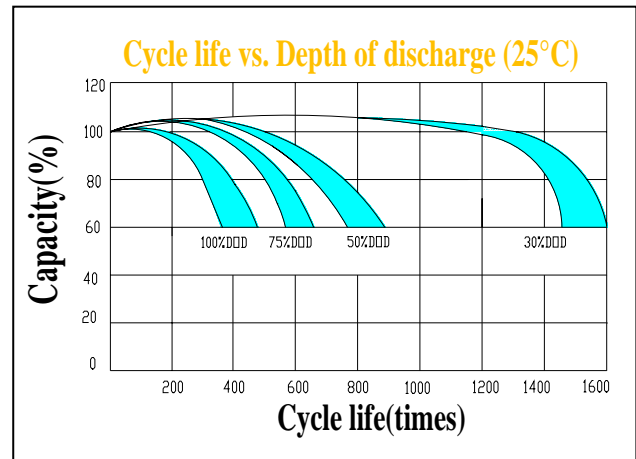
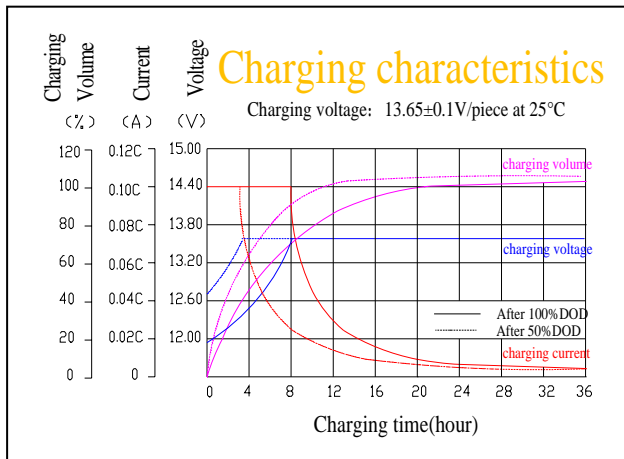

Battery Construction

Component	Positive plate	Negative plate	Container	Cover	Safety valve	Terminal	Separator	Electrolyte
Raw material	Lead dioxide	Lead	ABS	ABS	Si-Rubber	Copper	Fiberglass	GEL