

### Product Image

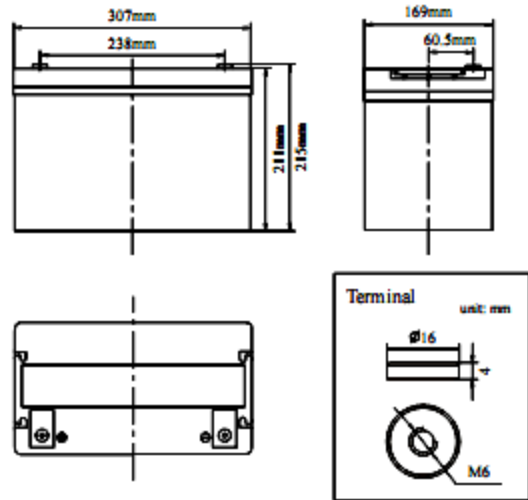

### Product Dimensions



### Characteristics

Nominal Voltage		12V
Nominal Capacity (20 hour rate)		100Ah
Capacity 25°C (77°F)	10 hour rate (9.0A)	90.0Ah
	5 hour rate (15.9A)	87.5Ah
	1 hour rate (55.4A)	55.4Ah
Internal Resistance	Full Charged Battery 25°C	≤5.3mΩ
Capacity affected by Temperature (10 hour)	40°C (104°F)	102%
	25°C (77°F)	100%
	0°C (32°F)	90%
	-15°C (5°F)	70%
Self-Discharge 25°C (77°F) Capacity	after 3 month storage	92%
	after 6 month storage	84%
	after 12 month storage	65%
Charge (Constant Voltage) 25°C (77°F)	Float	Initial Charging Current Less than 20A Voltage 13.6-13.8V
	Cycle	Initial Charging Current Less than 20A Voltage 14.4-14.9V

### Packaging

Battery Dimensions	Length	307mm
	Width	169mm
	Height	211mm
	Total Height	215mm
Box Dimensions	Length	322mm
	Width	184mm
	Height	251mm
Quantity Per Box		1 PC per box
Net weight Per Cell		30 kg±200g
Net weight Per Box		30kg
Gross Weight		30.5kg

#### Discharge Constant Current per Cell (Amperes at 77°F/25°C)

F.V/Time	5min	10min	15min	30min	45min	1h	2h	3h	5h	8h	10h	20h
1.60V	237.6	151.5	128.7	82.2	60.4	55.4	35.2	24.8	16.8	11.1	9.9	5.5
1.65V	233.3	148.7	126.4	80.7	59.3	54.4	34.6	24.3	16.5	10.9	9.7	5.4
1.70V	229.0	146.0	124.0	79.2	58.2	53.4	34.0	23.9	16.2	10.7	9.5	5.3
1.75V	224.6	143.2	121.7	77.7	57.1	52.4	33.3	23.4	15.9	10.5	9.4	5.2
1.80V	216.0	137.7	117.0	74.7	54.9	50.4	32.0	22.5	15.3	10.1	9.0	5.00

#### Discharge Constant Power per Cell (Watts at 77°F 25°C)

F.V/Time	5min	10min	15min	30min	45min	1h	2h	3h	5h	8h	10h	20h
1.60V	457.4	291.6	247.7	158.2	116.3	106.7	67.8	47.6	32.4	21.3	19.1	10.6
1.65V	449.1	286.3	243.2	155.3	114.1	104.8	66.6	46.8	31.8	21.0	18.7	10.4
1.70V	440.7	281.0	238.7	152.4	112.0	102.8	65.4	45.9	31.2	20.6	18.4	10.2
1.75V	432.4	275.7	234.2	149.5	109.9	100.9	64.1	45.0	30.6	20.2	18.0	10.0
1.80V	415.8	265.1	225.2	143.8	105.7	97.0	61.7	43.3	29.5	19.4	17.3	9.6

**Note** The above data are average values, and can be obtained within 3 charge/discharge cycles. These are not minimum values. Cell and battery designs/specifications are subject to modification without notice. Contact **MCA** for the latest information.

## Performance Characteristics

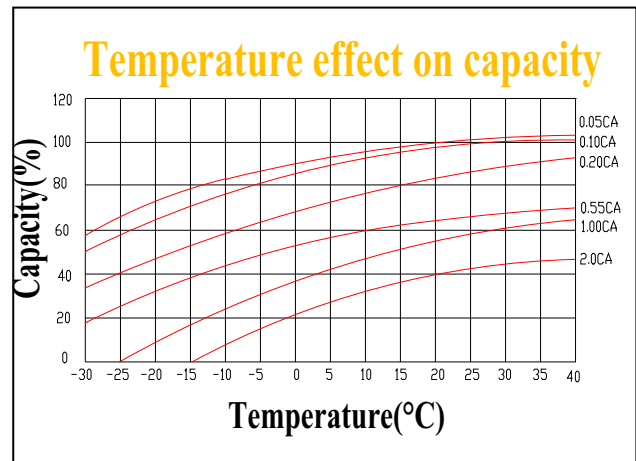
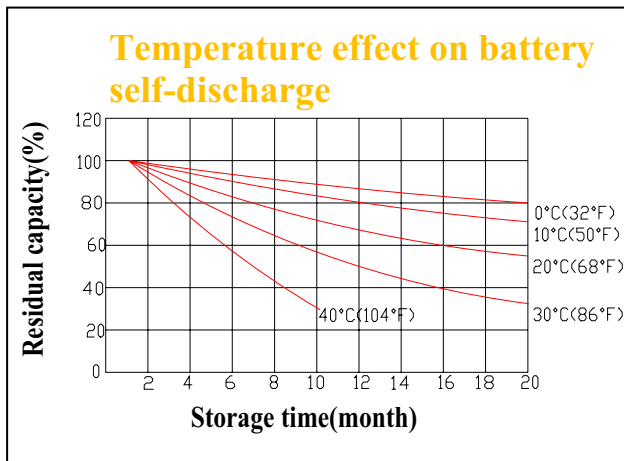
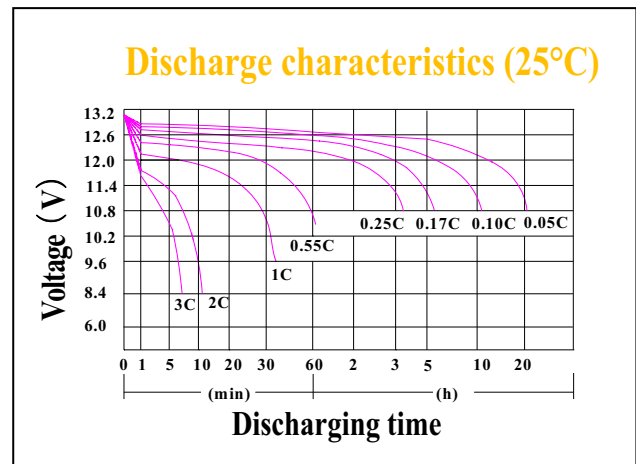
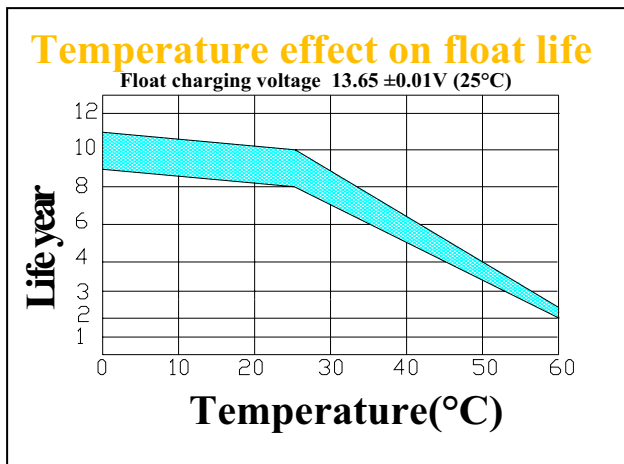
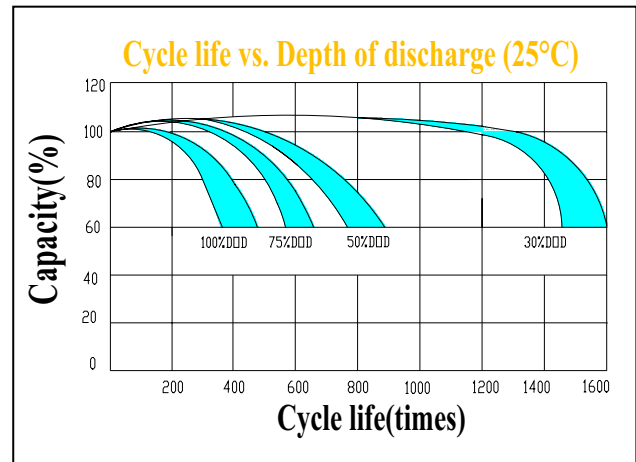
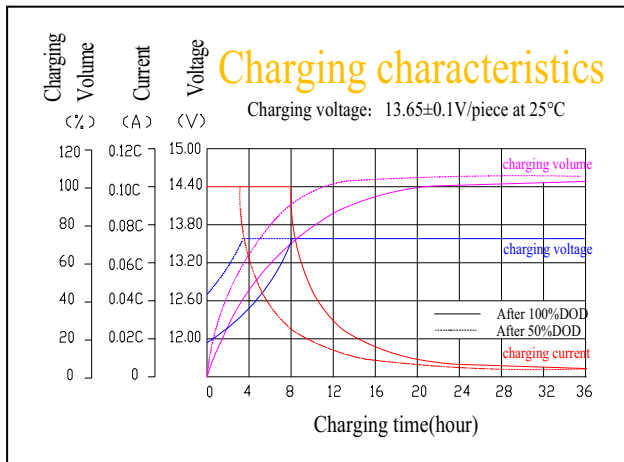

## Battery Construction

Component	Positive plate	Negative plate	Container	Cover	Safety valve	Terminal	Separator	Electrolyte
Raw material	Lead dioxide	Lead	ABS	ABS	Si-Rubber	Copper	Fiberglass	GEL